

AHUJA®

PA Mixer Amplifier

80W RMS/110W Max.

OPERATION MANUAL

SSB-80® M

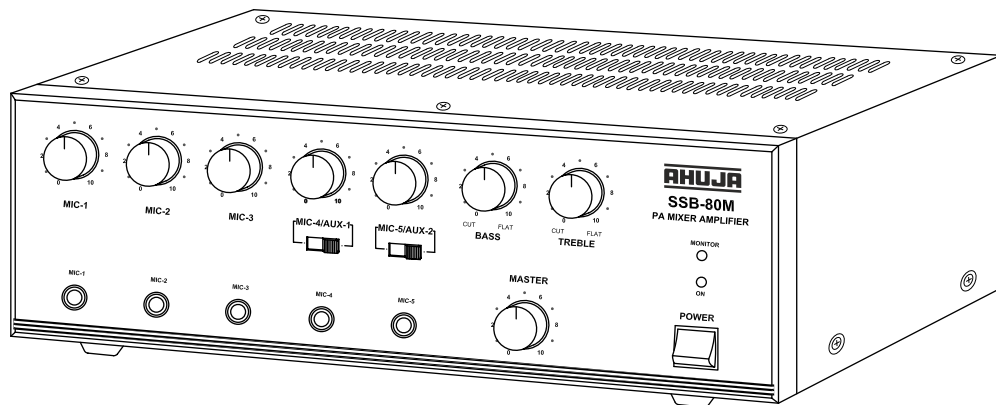

- ◆ Thank you for purchasing the AHUJA PA Mixer Amplifier.
- ◆ Please read this manual thoroughly before making connections and turning on the power. Following the instructions in this manual will enable you to obtain optimum performance from your new AHUJA PA Mixer Amplifier.
- ◆ Please retain this manual for future reference.

• Safety Instructions

Read the Instructions: Please read all the instructions in this section carefully before installation or use of the product. All the safety instructions must be followed.

Retain the Instructions: Please retain this Instruction Manual for future reference.



This symbol, wherever it appears, alerts you to the presence of uninsulated hazardous voltage that may be sufficient to constitute a risk of electric shock. External wiring to any terminal marked with this symbol must be done by a trained and instructed person only.



This symbol, wherever it appears adjacent to a component, alerts you that the concerned component can only be replaced by another of the exact same specifications.

WARNING

- To reduce the risk of electric shock, do not remove the top cover. No user serviceable parts inside. Refer all servicing to qualified personnel only.
- Before replacing any fuse, make sure the set is switched off and disconnected from the AC mains or any other power source. Replace a fuse only with another of exactly same specification.

CAUTIONS

Water & Moisture: To reduce the risk of fire or electrical shock, do not expose this set to rain or moisture. Do not use this set near water or in a wet location. Do not keep any object filled with liquid, such as a vase, on top of this set. Do not insert or remove the AC mains plug with wet hands.

Power Source: The voltage & frequency of the AC mains supply, and the voltage of the external battery, (if applicable) to which this set can be connected, is marked on the rear panel of the set. Do not connect this set to any power source other than those specified on the rear panel.

Power Cord Protection: Do not cut, kink, damage or modify the AC power cord supplied with this set. Keep the AC power cord away from heaters and harmful chemicals. Do not keep any heavy object on the power cord.

Operation on Generator: When operating this set on a generator, make sure the set is switched off till the generator voltage has stabilized.

Ventilation: This set should be situated so that its location or position does not interfere with its proper ventilation. Do not cover the ventilation holes / slots. Do not insert or drop anything into the ventilation holes / slots.

Stability: This set must be kept in a stable and flat horizontal position, and never in a tilted position. Do not place this set on an unstable stand, tripod, bracket or mount. Do not use attachments which are not supplied or explicitly recommended by the manufacturer.

Cover Strip: The cover strip of the 100V / 70V audio output terminal strip, and of any other high voltage output terminal strip, must be replaced after making connections. Failure to do so may result in exposure to hazardous voltages.

Earthing: This set must be earthed properly before use. A wire from the Earth terminal on the rear panel must be connected to electrical earth.

Cleaning: Disconnect this equipment from the AC mains and external battery before cleaning. Clean with a damp cloth, but do not allow any liquid to enter the set. Do not clean with liquids or aerosols.

Exposure to Heat: Do not touch the heatsinks while the set is working.

• Table of Contents

Contents	Page No.
• Features/General Description of Product	4
• Front Panel Controls & Features	5
• Rear Panel Controls & Features	6
• Interconnections	7
• Speaker Connections Guidelines	9
• Specifications	12

• Features/General Description of Product

- Designed for use in a wide variety of PA applications.
- SSB-80®M is an 80 watts Mixer Amplifier with five Independent Unbalanced Mic inputs and Two Independent Auxillary inputs.
- Mic 1 to Mic 3 have Independent volume controls. Mic 4 and Mic 5 are switchable with Aux 1 and Aux 2 respectively.
- SSB-80®M has a preamp output for recording the program & connecting to a booster amplifier.
- Provision for automatic changeover from AC to battery operation ensuring continuity of program has been provided.
- Protection provided against the reverse polarity of battery connections.
- Ease of operation, combined with service accessibility has been optimized in the design.

• Front Panel Controls & Features

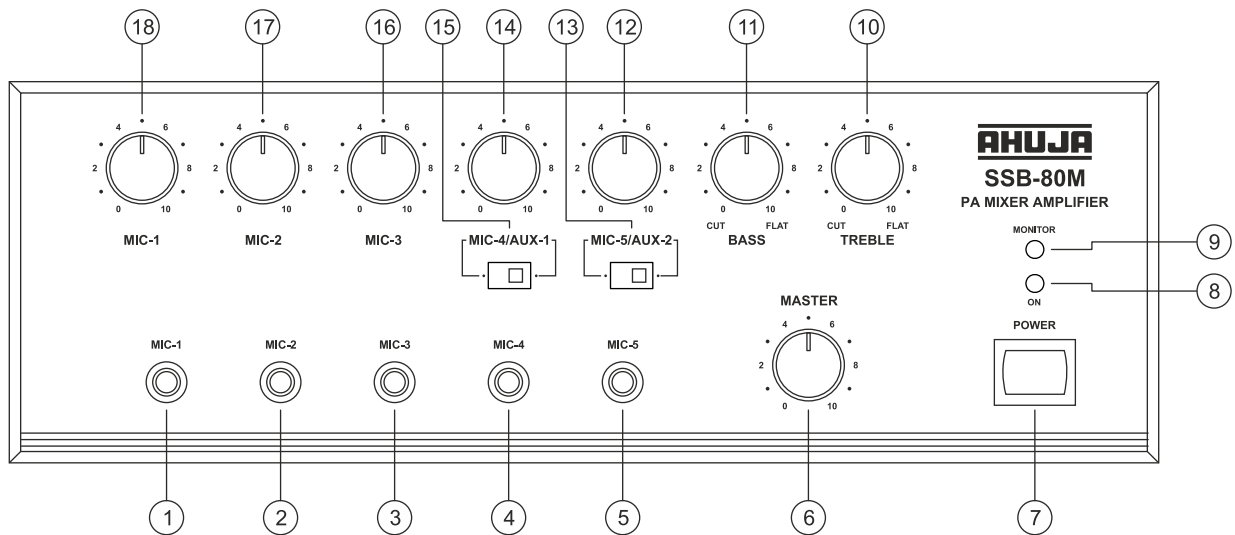

1. **MIC-1 Input Jack Socket**
For accepting unbalanced signal from a low impedance microphone.
2. **MIC-2 Input Jack Socket**
3. **MIC-3 Input Jack Socket**
4. **MIC-4 Input Jack Socket**
5. **MIC-5 Input Jack Socket**
6. **MASTER Volume Control**
For adjustment of the overall volume level from the amplifier.
7. **POWER Switch**
Push the top part of the knob to switch the amplifier ON. Push the bottom part of the knob to switch the amplifier OFF.
8. **POWER LED**
This glows when the amplifier is switched ON.
9. **MONITOR LED**
This indicates the output level.
10. **TREBLE Control**
For attenuating the signal level of high frequencies.
11. **BASS Control**
For attenuating the signal level of low frequencies.
12. **MIC-5 / AUX-2 Volume Control**
13. **MIC-5 / AUX-2 Selector Switch**
14. **MIC-4 / AUX-1 Volume Control**
15. **MIC-4 / AUX-1 Selector Switch**
16. **MIC-3 Volume Control**
17. **MIC-2 Volume Control**
18. **MIC-1 Volume Control**

• Rear Panel Controls & Features

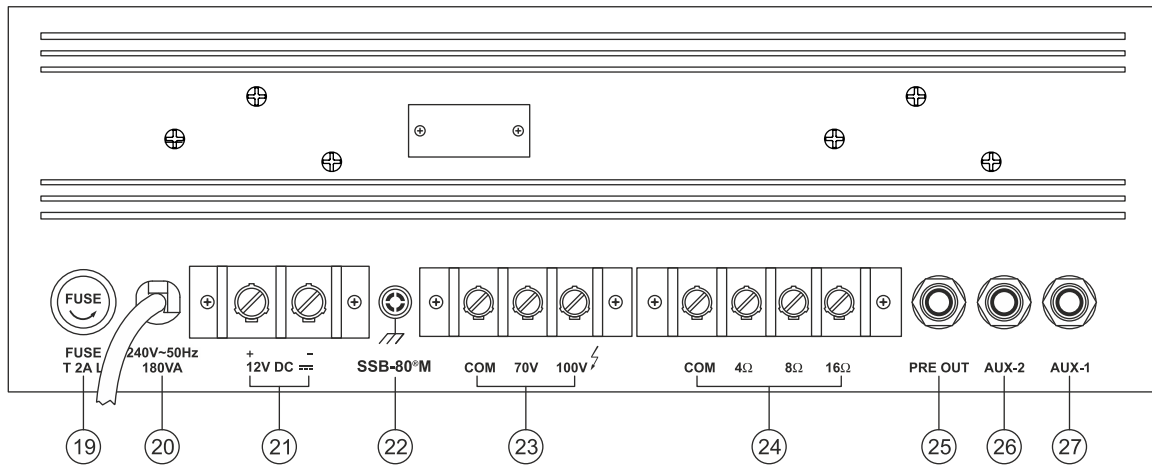

19. **AC MAINS FUSE Rating 2 AMP 250V (T 2A L)**
This protects the amplifier from any excessive current flow.
20. **3 CORE AC MAINS CABLE With Plug**
21. **BATTERY Terminal Block**
For connecting 12V Car Battery as standby power source.
22. **EARTH Terminal**
23. **SPEAKER Terminal Block (70V, 100V)**
For connecting speakers with 100V line matching transformers.
24. **SPEAKER Terminal Block (4Ω, 8Ω and 16Ω)**
For connecting low impedance speakers.
25. **PRE AMPLIFIER Output Jack Socket**
For connecting to the AUX input of another amplifier or a recorder for recording purpose.
26. **AUX-2 Input Jack Socket**
For accepting an unbalanced signal from an auxiliary source like a CD Player, Tuner, MP3 Player, Echo or Audio Mixer etc.
27. **AUX-1 Input Jack Socket**

CAUTION

- The equipment must be earthed properly before operating it to avoid electric shock. A wire from the Earth Terminal must be connected to electrical earth for safe operation.

• Interconnections

- The amplifier can be placed as a table top unit. The amplifier should be situated so that its location or position does not interfere with its proper ventilation.
- The amplifier must be powered through an earthed AC mains outlet.
- All connections must only be carried out or changed with the amplifier switched OFF.
- The amplifier may be operated from a DC supply of 12 Volts.
- To avoid loud switching noise, always switch ON the amplifier after all other units of the audio system have been switched ON. After operation switch it OFF first and then the other units.
- The connection diagrams that follow display the typical types of input sources (Mics, Keyboard, MP3 Player, Mixer, CD Player etc.) and speakers (Wall, Ceiling, Box, Horn, Column) which can be connected to the amplifier. For correct connections and operation check the specifications of the connected equipment.

FRONT PANEL - SSB-80[®]M

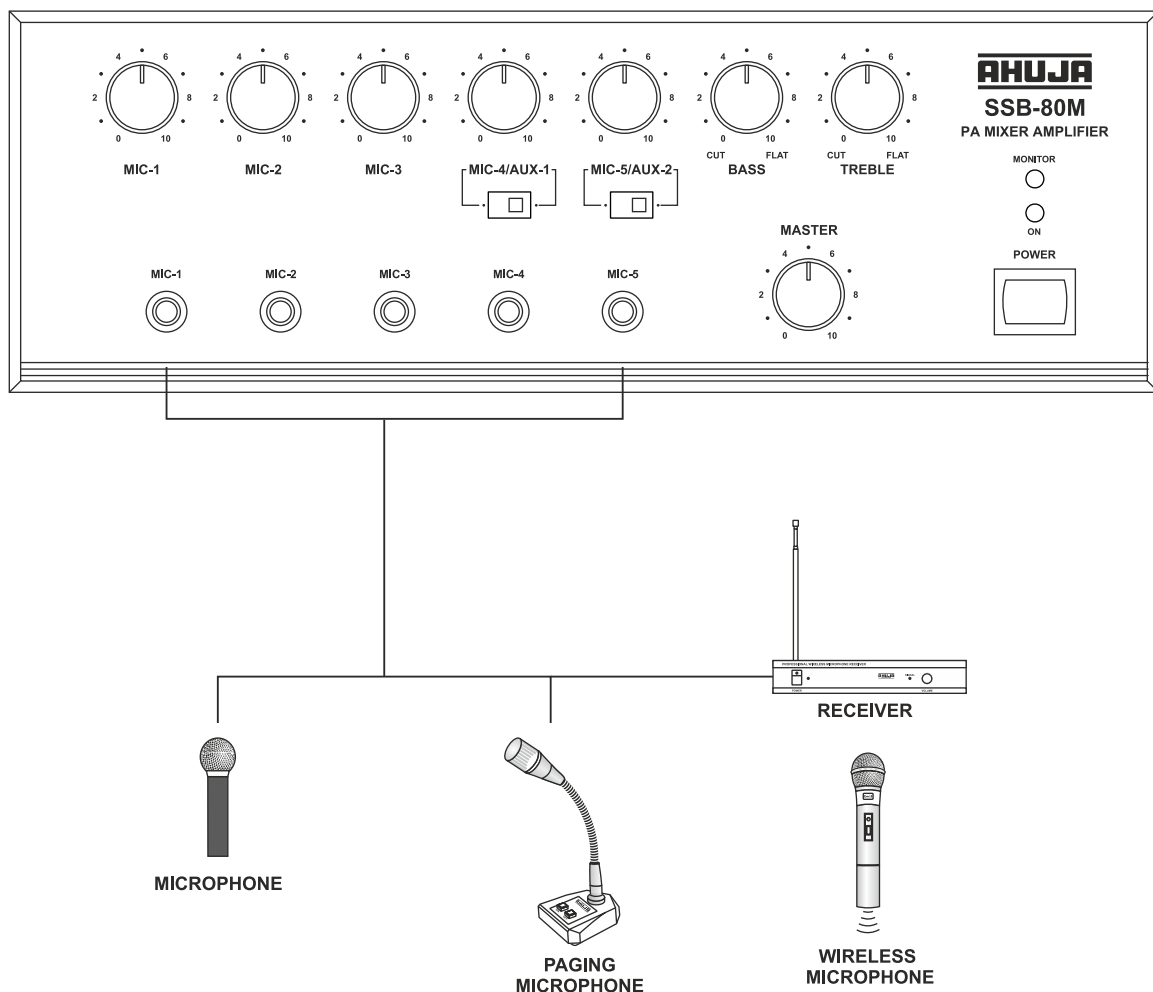

Interconnections....

REAR PANEL - SSB-80®M

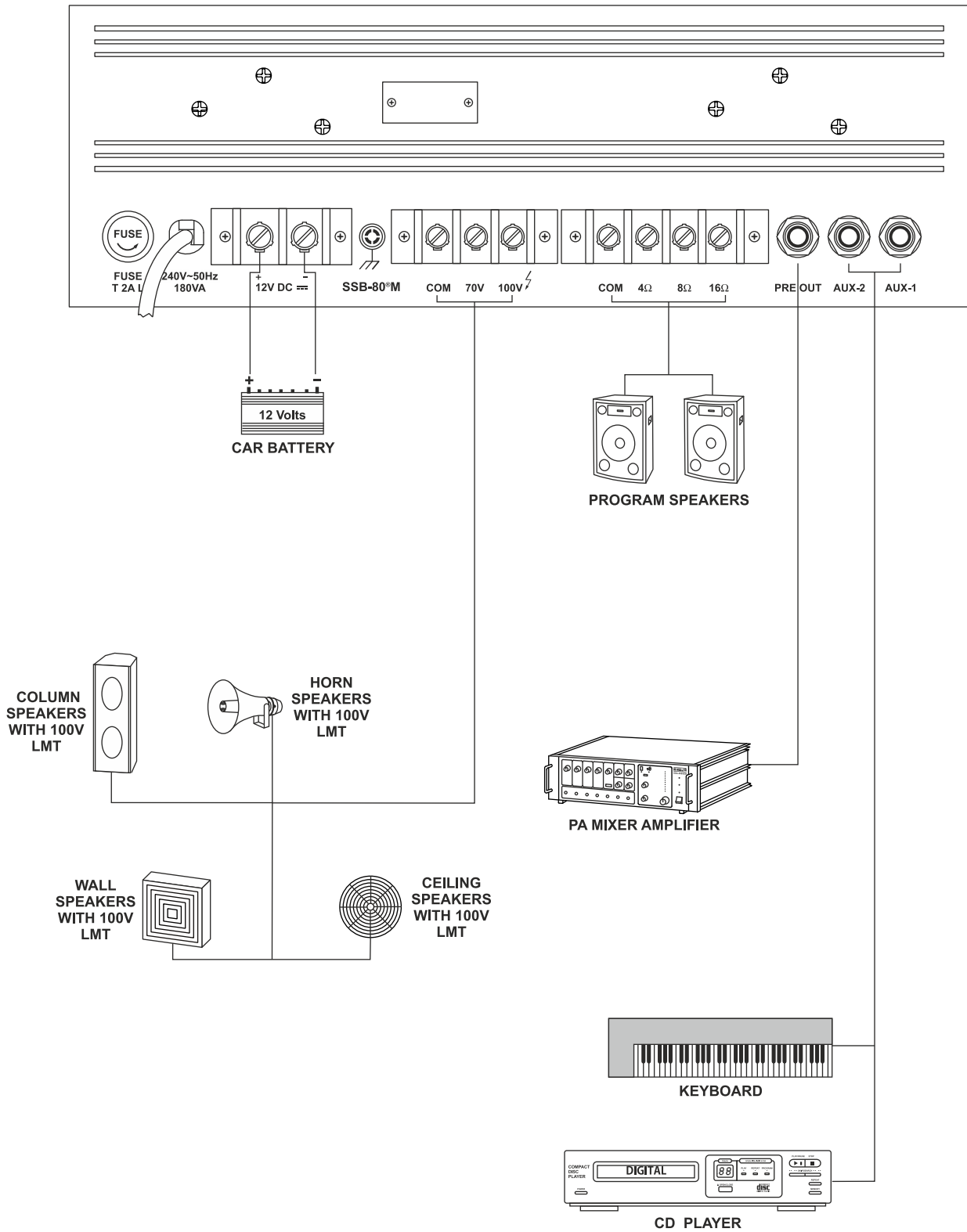

• Speaker Connection Guidelines

SSB-80[®]M is a medium power PA Mixer amplifier. Therefore it is very important that correct loudspeaker connections are made to avoid damage to the amplifier or speakers.

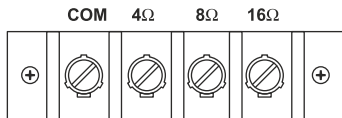

Low Impedance Speaker Connections

- Box Type Speakers like SRX-50DX can be directly connected to COM - 4Ω / 8Ω / 16Ω Terminal Strip.
- Driver Units without Line Matching Transformers like AU-35 / AU-40 / AU-60 can be directly connected to COM - 4Ω / 8Ω / 16Ω Terminal Strip.
- Column Speaker without Line Matching Transformers like SCM-15 / SCM-30 can be directly connected to COM - 4Ω / 8Ω / 16Ω Terminal Strip.

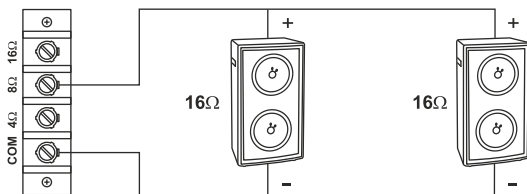

Resultant Impedance = $16/2 = 8$ ohms

Connecting Two SRX-50DX Speakers

The Two loudspeakers should be wired in parallel as shown in figure. The resulting impedance of the speaker system is 8Ω . Thus they should be connected to the 8Ω Tap of the amplifier.

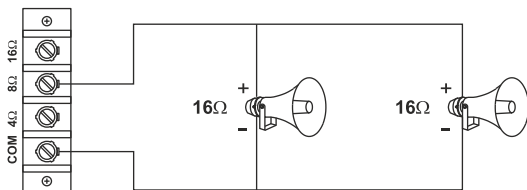

Resultant Impedance = $16/2 = 8$ ohms

Connecting Two AU-60 Driver Units

When connecting two Driver Units, high power Driver Units like AU-60 should only be used. They should be wired in parallel as shown in figure. Two 16Ω Units would combine to give 8Ω impedance. The system should be connected to the 8Ω Tap of the amplifier.

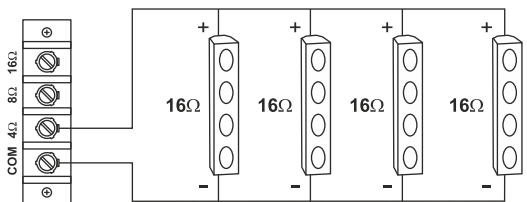

Resultant Impedance = $16/4 = 4$ ohms

Connecting Four SCM-30 Speakers

The four column speakers should be connected in parallel. The resulting impedance would be 4Ω. Thus they should be connected to the 4Ω Tap of the amplifier.

IMPORTANT

- When speakers are connected to COM - 4Ω / 8Ω / 16Ω Terminal Strip NO speakers should be connected to the Red Terminal Strip marked COM - 70V / 100V.
- Speakers should be connected only to either COM - 4Ω or COM - 8Ω or COM - 16Ω terminals as illustrated above but never to more than one set of terminals.

• Speaker Connection Guidelines....

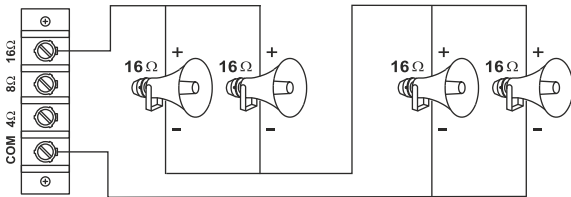

Resultant Impedance = $(16/2) \times 2 = 8 \times 2 = 16 \text{ ohms}$

Connecting Four AU-35/AU-40 Driver Units

Four driver units should be wired in a parallel-series combination as shown in the figure. The resulting impedance will be 16Ω. The speaker system should be connected to the 16Ω tap of the amplifier.

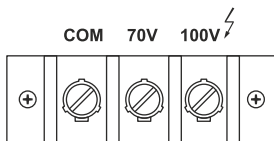

High Impedance Speakers or Speakers Using A 100V Line Matching Transformer

- Driver Units / Horn Speakers / Column Speakers with 100V Line Matching Transformers are only to be connected to COM - 70V / 100V Terminal Strip.
- When any of the above speakers are connected to the COM - 70V / 100V Terminal Strip then NO speakers should be connected to the COM - 4Ω / 8Ω / 16Ω Terminal Strip.
- The power drawn from the amplifier should not exceed 80 Watts.

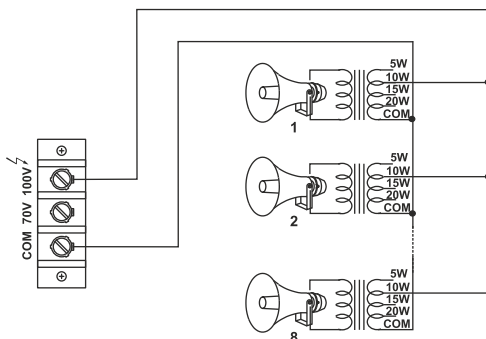

Connecting Eight Driver Units with 100V LMT

- 8 Driver Units with 100V Line Matching Transformer connected at 10 Watts tap can be operated.

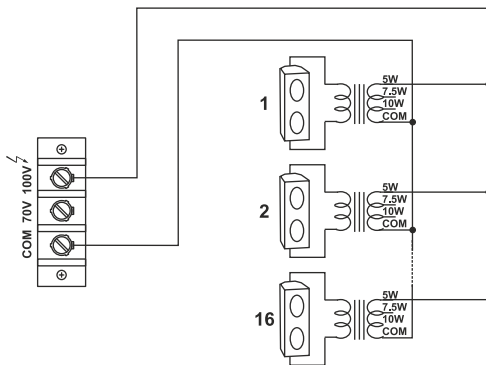

Connecting Column Speakers with 100V LMT

- 16 Column Speakers with 100V LMT connected at 5 Watts tap can be operated.

• Speaker Connection Guidelines....

Use of 70 Volt Line

A loudspeaker with its LMT adjusted to the 10W tap, when connected to COM and 100V terminals on the amplifier's Terminal Strip will draw 10W from the amplifier but when the same is connected to COM and 70V it will only draw half power i.e. 5W. A good use of 70V line tap can be made in installations where large number of speakers/ driver units are to be installed for more even distribution of sound.

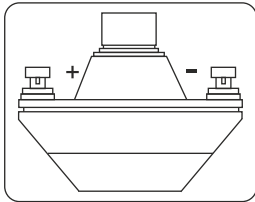

Correct Phasing of Loudspeakers

- When two or more Speakers / Units are installed in the same area and are facing the same direction, it is essential that their cones/diaphragms act in unison. Otherwise the sound level of one speaker will be canceling the sound level of the other. To avoid any mistake, the terminals of Box Speakers and the Driver Units are marked '+' & '-'. Always connect the COM of the Amplifier to '-' of speaker & 4Ω/8Ω/16Ω of the amplifier to the '+' of the speakers.
- In case of LMTs the COM of all the LMTs should be connected to the COM of the red strip terminal of the amplifier and the power tap to 100V line as shown in figure.

IMPORTANT

- When 70 / 100 Volt line is being used, no speakers / driver units should be connected to 4Ω / 8Ω / 16Ω (Low Impedance) Tap.
- Loudspeaker / driver unit should be connected to either COM - 100V or COM - 70V terminals, but never to more than one set of terminals.

• Specifications

Model	SSB-80[®]M
Power Output	110W RMS Max. 80W RMS at 10% THD 75W RMS at 5% THD 60W RMS at 2% THD
Output Regulation	≤ 2dB no load to full load at 1kHz
Input Channels	5 × Mic. 0.65mV / 4.7kΩ (Mic source impedance 50Ω to 1kΩ) 2 × Aux. 100mV / 470kΩ
Frequency Response	65 – 15000 Hz ±3dB
Signal to Noise Ratio	60dB
Tone Controls	Bass: -10dB at 100Hz Treble: -10dB at 10kHz
Pre-amp Output	200mV / 600Ω
Output Taps For Speaker Matching	4Ω, 8Ω & 16Ω (for direct connections) 70 & 100V Line (for use with LMT)
Power Supply	AC: 220 - 240V 50 / 60Hz (110V on request); DC: 12V (Car Battery)
Protection	AC: Fuse 2Amp. (T 2AL); DC: Fuse 10Amp. (T 10AL)
AC Power Consumption	180VA
DC Power Consumption	3A (average)
Dimensions	W355 x H133 x D285 mm
Weight	7.83 kg approx.

AHUJA RADIOS • 215, Okhla Industrial Estate, New Delhi - 110 020, INDIA
Tel.: +91-11-26831549, 41612474 Fax : +91-11-26847287
E-mail : ahuja@ahujaradios.com, admin@ahujaradios.com
Website: www.ahujaradios.com

- Design and Specifications are subject to change without notice owing to continuous product up-gradation
- Technical specifications are subject to production tolerances.
- We cannot be held responsible for printing errors, should they occur.
- **AHUJA** is a registered trademark of Ahuja Radios in India and other countries.
- © Copyright Ahuja Radios, 2013. All rights reserved. Any unauthorized reproduction or use of logos, images or design elements is strictly prohibited by law.
- No part of this compilation may be reproduced in any manner or translated without written permission.

